

Air-Conditioners For Building Application**INDOOR UNIT****CE****PEFY-P-VMH-E****INSTALLATION MANUAL**

For safe and correct use, please read this installation manual thoroughly before installing the air-conditioner unit.

INSTALLATIONSHANDBUCH

Zum sicheren und ordnungsgemäßen Gebrauch der Klimageräte das Installationshandbuch gründlich durchlesen.

MANUEL D'INSTALLATION

Veillez lire le manuel d'installation en entier avant d'installer ce climatiseur pour éviter tout accident et vous assurer d'une utilisation correcte.

MANUAL DE INSTALACIÓN

Para un uso seguro y correcto, lea detalladamente este manual de instalación antes de montar la unidad de aire acondicionado.

MANUALE DI INSTALLAZIONE

Per un uso sicuro e corretto, leggere attentamente questo manuale di installazione prima di installare il condizionatore d'aria.

INSTALLATIEHANDLEIDING

Voor een veilig en juist gebruik moet u deze installatiehandleiding grondig doorlezen voordat u de airconditioner installeert.

MANUAL DE INSTALAÇÃO

Para segurança e utilização correctas, leia atentamente este manual de instalação antes de instalar a unidade de ar condicionado.

ΕΓΧΕΙΡΙΔΙΟ ΟΔΗΓΙΩΝ ΕΓΚΑΤΑΣΤΑΣΗΣ

Για ασφάλεια και σωστή χρήση, παρακαλείστε διαβάσετε προσεχτικά αυτό το εγχειρίδιο εγκατάστασης πριν αρχίσετε την εγκατάσταση της μονάδας κλιματισμού.

РУКОВОДСТВО ПО УСТАНОВКЕ

Для осторожного и правильного использования прибора необходимо тщательно ознакомиться с данным руководством по установке до выполнения установки кондиционера.

MONTAJ ELKİTABI

Emniyetli ve doğru biçimde nasıl kullanılacağını öğrenmek için lütfen klima cihazını monte etmeden önce bu elkitabını dikkatle okuyunuz.

安装手册

为了安全和正确地使用本空调器，请在安装前仔细阅读本安装手册。

PŘÍRUČKA K INSTALACI

V zájmu bezpečného a správného používání si před instalací klimatizační jednotky důkladně pročtěte tuto příručku k instalaci.

NÁVOD NA INŠTALÁCIU

Pre bezpečné a správne použitie si pred inštalovaním klimatizačnej jednotky, prosím, starostlivo prečítajte tento návod na inštaláciu.

TELEPÍTÉSI KÉZIKÖNYV

A biztonságos és helyes használatához, kérjük, olvassa el alaposan ezt a telepítési kézikönyvet, mielőtt telepítené a légkondicionáló egységet.

PODRECZNIK INSTALACJI

W celu bezpiecznego i poprawnego korzystania należy przed zainstalowaniem klimatyzatora dokładnie zapoznać się z niniejszym podręcznikiem instalacji.

GB

D

F

E

I

NL

P

GR

RU

TR

中

CZ

SV

HG

PO

[Fig. 3.1.1]

Type 40~140

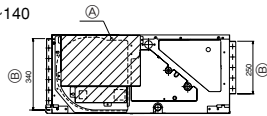

- (A) Fan and motor removal door
- (B) Duct dimension

Type 200 · 250

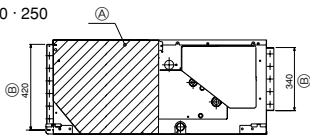

Type	A	B	C	D
PEFY-P40-50-63VMH-E	680	754	550	600
PEFY-P71-80VMH-E	930	1004	800	850
PEFY-P100-125-140VMH-E	1130	1204	1000	1050
PEFY-P200-250VMH-E	1250	1326	1100	1100

[Fig. 3.1.2]

Type 40~140

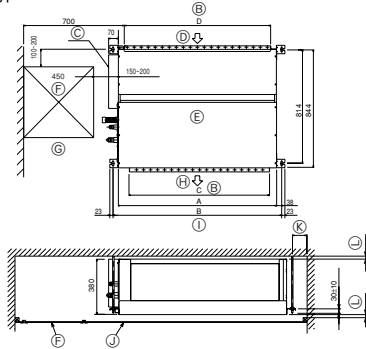

Type 200 · 250

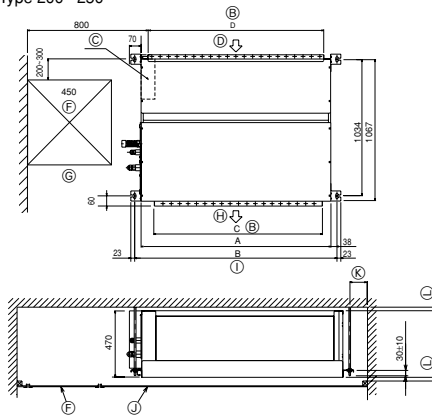

- (B) Duct dimension
- (C) Electrical components case
- (D) Air inlet
- (E) Top of unit
- (F) Access door
- (G) Servicing space
- (H) Air outlet
- (I) Hanging bolt spacing
- (J) Ceiling
- (K) 100 min.
- (L) 20 min.

[Fig. 4.1.1]

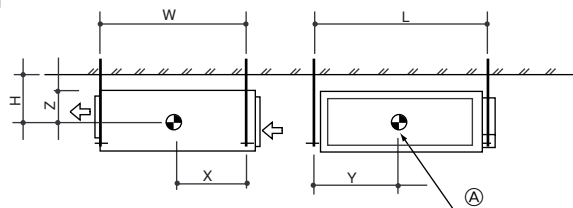

- (A) Center of gravity

[Fig. 5.1.1]

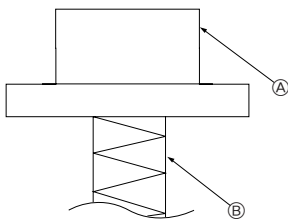

- (A) Unit body
- (B) Lifting machine

[Fig. 5.1.2]

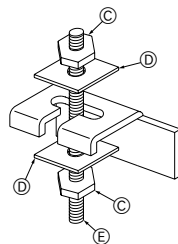

- (C) Nuts (field supply)
- (D) Washers
- (E) M10 Hanging bolt (field supply)

[Fig. 5.2.1]

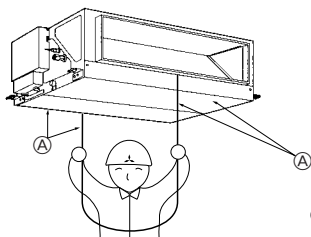

- (A) Bottom of indoor unit

[Fig. 6.1.1]

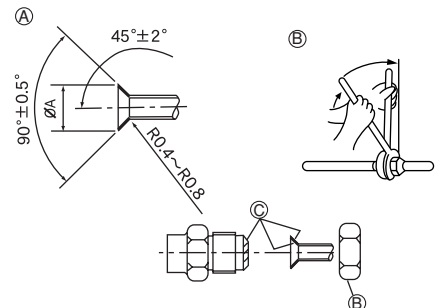

- (A) Flare cutting dimensions
- (B) Refrigerant pipe sizes & Flare nut tightening torque
- (C) Apply refrigerating machine oil over the entire flare seat surface

[Fig. 6.2.1]

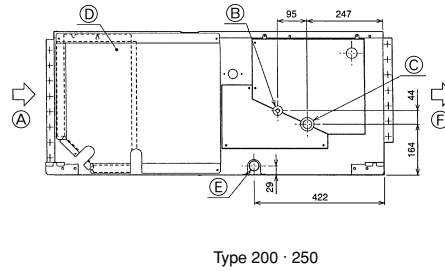
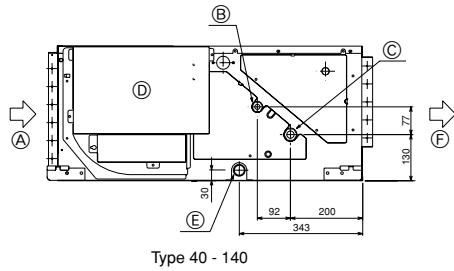

- A Air inlet
- B Refrigerant piping (liquid)
- C Refrigerant piping (gas)
- D Control box
- E Drain outlet
- F Air outlet

6.3

[Fig. 6.3.1]

Type 40 - 140

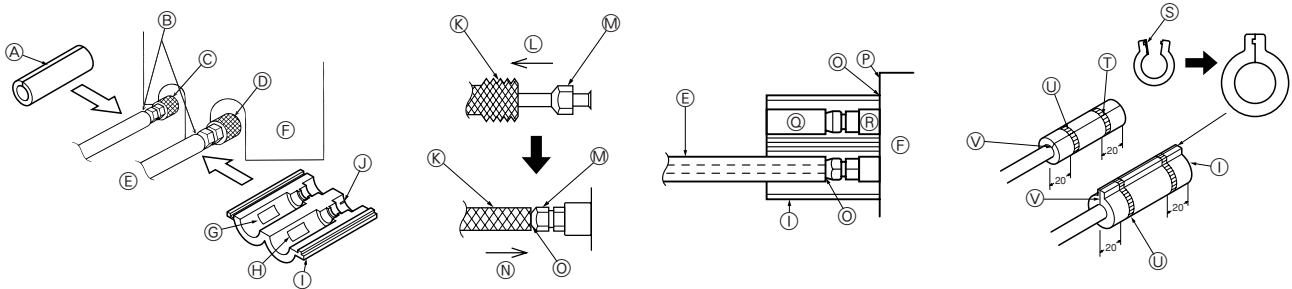

- A Thermal insulation tubing 1
- B Caution:
Pull out the thermal insulation on the refrigerant piping at the site, insert the flare nut to flare the end, and replace the insulation in its original position.
Take care to ensure that condensation does not form on exposed copper piping.
- C Liquid end of refrigerant piping
- D Gas end of refrigerant piping
- E Site refrigerant piping
- F Main body
- G Marked "GAS"
- H Marked "OUTSIDE"
- I Flared insulation (supplied) 2
- J Marked "INSIDE"
- K Thermal insulation
- L Pull
- M Flare nut
- N Return to original position
- O Ensure that there is no gap here
- P Plate on main body
- Q Outside
- R Inside
- S Remove tape
- T Thermal insulation tubing (small) (supplied) 1
- U Tie (large) (supplied) 4
- V Ensure that there is no gap here. Place join upwards.

[Fig. 6.3.2]

Type 200 · 250

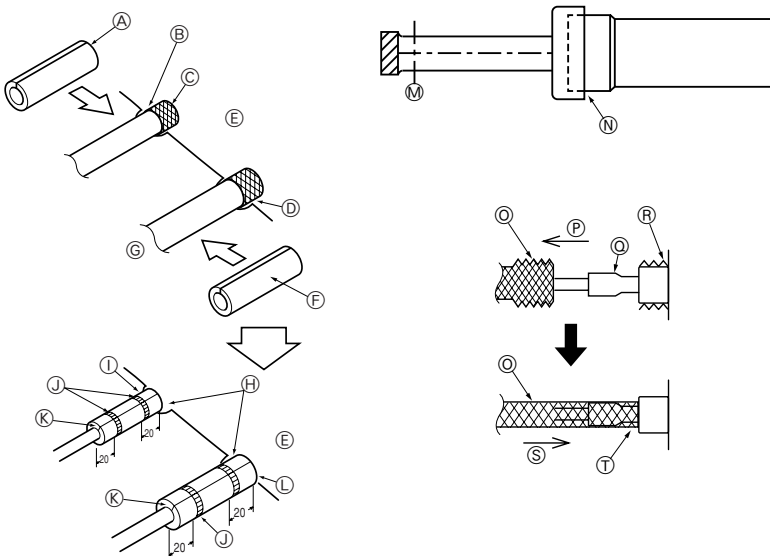

- A Thermal insulation tubing 1
- B Caution:
Pull out the thermal insulation on the refrigerant piping at the site, braze the piping, and replace the insulation in its original position.
Take care to ensure that condensation does not form on exposed copper piping.
- C Refrigerant piping (liquid)
- D Refrigerant piping (gas)
- E Main body
- F Thermal insulation tubing 2
- G Site refrigerant piping
- H Ensure that there are no gaps between the insulation and the main body.
- I Thermal insulation tubing (small) (supplied) 1
- J Ties (large) (supplied) 4
- K Ensure that there is no gap here. Place join upwards.
- L Thermal insulation tubing (medium) (supplied) 2
- M Cut
- N Release gas before removing the brazing.
- O Thermal insulation
- P Pull
- Q Flared pipe end
- R Wrap with damp cloth
- S Return to original position
- T Ensure that there is no gap here.

[Fig. 7.2.1]

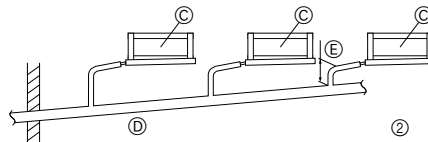
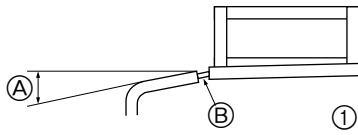

- (A) Downward slope 1/100 or more
- (B) Drain hose (Accessory)
- (C) Indoor unit
- (D) Collective piping
- (E) Maximize this length to approx. 10 cm

[Fig. 8.0.1]

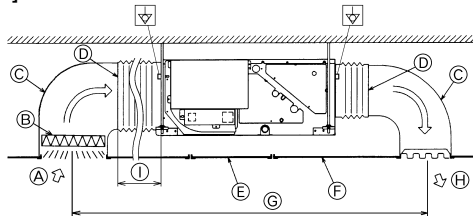

- (A) Air inlet
- (B) Air filter (supplied at site)
- (C) Duct
- (D) Canvas duct
- (E) Access door
- (F) Ceiling
- (G) Ensure sufficient length to prevent short cycling
- (H) Air outlet
- (I) Keep duct-work length 850 mm or more

[Fig. 9.1.1]

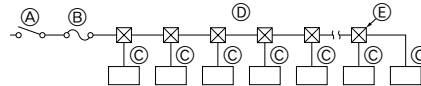

- (A) Switch 16 A
- (B) Overcurrent protection 16 A
- (C) Indoor unit
- (D) Total operating current be less than 16 A
- (E) Pull box

[Fig. 9.2.1]

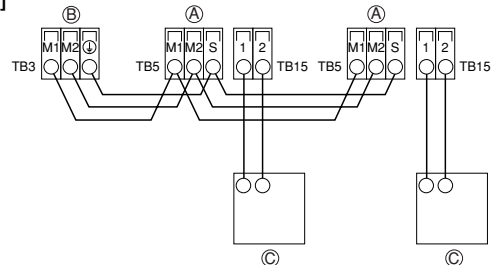

[Fig. 9.2.2]

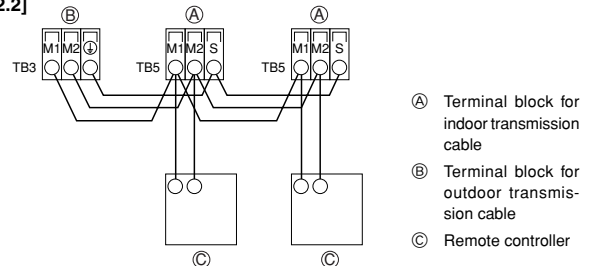

- (A) Terminal block for indoor transmission cable
- (B) Terminal block for outdoor transmission cable
- (C) Remote controller

[Fig. 9.3.1]

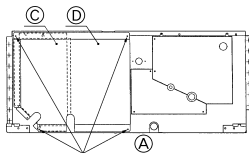
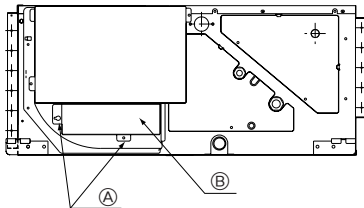

- (A) Screws
- (B) Terminal box cover
- (C) Control box cover
- (D) Control box

[Fig. 9.3.2]

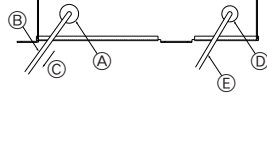
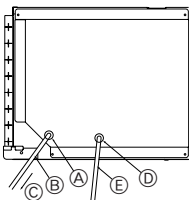

- (A) To prevent external tensile force from applying to the wiring connection section of power source terminal block use buffer bushing like PG connection or the like.
- (B) Power source wiring
- (C) Tensile force
- (D) Use ordinary bushing
- (E) Transmission wiring

[Fig. 9.2.3]

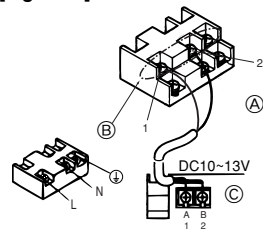

[Fig. 9.2.4]

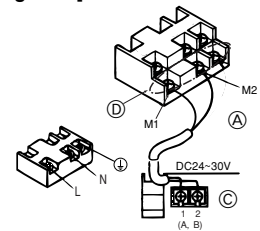

- (A) Non-polarized
- (B) Upper level (TB15)
- (C) Remote Controller
- (D) Lower level (TB5)

[Fig. 9.5.1]

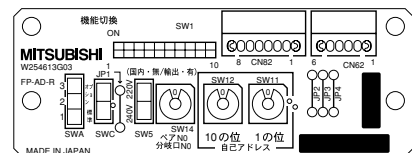

<Address board>

Contents

1. Safety precautions	5	6.1. Refrigerant pipe and drain pipe specifications	8
1.1. Before installation and electric work	5	6.2. Refrigerant pipe, drain pipe and filling port	8
1.2. Precautions for devices that use R410A or R407C refrigerant ..	5	6.3. Request for refrigerant piping connection	8
1.3. Before getting installed	6	7. Connecting refrigerant pipes and drain pipes	9
1.4. Before getting installed (moved) - electrical work	6	7.1. Refrigerant piping work	9
1.5. Before starting the test run	6	7.2. Drain piping work	9
2. Indoor unit accessories	6	8. Duct work	9
3. Selecting an installation site	7	9. Electrical wiring	9
3.1. Installation and servicing space	7	9.1. Power supply wiring	10
3.2. Combining indoor units with outdoor units	7	9.2. Connecting remote controller, indoor and outdoor transmission cables	10
4. Fixing hanging bolts	7	9.3. Connecting electrical connections	10
4.1. Fixing hanging bolts	7	9.4. Selecting the static pressure	11
5. Installing the unit	7	9.5. Setting addresses	11
5.1. Hanging the unit body	7	9.6. Sensing room temperature with the built-in sensor in a remote controller	11
5.2. Confirming the unit's position and fixing hanging bolts	7		
6. Refrigerant pipe and drain pipe specifications	8		

1. Safety precautions

1.1. Before installation and electric work

- ▶ Before installing the unit, make sure you read all the “Safety precautions”.
- ▶ The “Safety precautions” provide very important points regarding safety. Make sure you follow them.

Symbols used in the text





Warning:

Describes precautions that should be observed to prevent danger of injury or death to the user.

Caution:

Describes precautions that should be observed to prevent damage to the unit.

Symbols used in the illustrations

-  : Indicates an action that must be avoided.
-  : Indicates that important instructions must be followed.
-  : Indicates a part which must be grounded.
-  : Indicates that caution should be taken with rotating parts. (This symbol is displayed on the main unit label.) <Color: yellow>
-  : Beware of electric shock (This symbol is displayed on the main unit label.) <Color: yellow>

Warning:

Carefully read the labels affixed to the main unit.

Warning:

- **Ask the dealer or an authorized technician to install the air conditioner.**
 - Improper installation by the user may result in water leakage, electric shock, or fire.
- **Install the air unit at a place that can withstand its weight.**
 - Inadequate strength may cause the unit to fall down, resulting in injuries.
- **Use the specified cables for wiring. Make the connections securely so that the outside force of the cable is not applied to the terminals.**
 - Inadequate connection and fastening may generate heat and cause a fire.
- **Prepare for typhoons and other strong winds and earthquakes and install the unit at the specified place.**
 - Improper installation may cause the unit to topple and result in injury.
- **Always use an air cleaner, humidifier, electric heater, and other accessories specified by Mitsubishi Electric.**
 - Ask an authorized technician to install the accessories. Improper installation by the user may result in water leakage, electric shock, or fire.
- **Never repair the unit. If the air conditioner must be repaired, consult the dealer.**
 - If the unit is repaired improperly, water leakage, electric shock, or fire may result.
- **Do not touch the heat exchanger fins.**
 - Improper handling may result in injury.
- **When handling this product, always wear protective equipment.**
EG: Gloves, full arm protection namely boiler suit, and safety glasses.
 - Improper handling may result in injury.
- **If refrigerant gas leaks during installation work, ventilate the room.**
 - If the refrigerant gas comes into contact with a flame, poisonous gases will be released.
- **Install the air conditioner according to this Installation Manual.**
 - If the unit is installed improperly, water leakage, electric shock, or fire may result.

- **Have all electric work done by a licensed electrician according to “Electric Facility Engineering Standard” and “Interior Wire Regulations” and the instructions given in this manual and always use a special circuit.**
 - If the power source capacity is inadequate or electric work is performed improperly, electric shock and fire may result.
- **Keep the electric parts away from water (washing water etc.).**
 - It might result in electric shock, catching fire or smoke.
- **Securely install the outdoor unit terminal cover (panel).**
 - If the terminal cover (panel) is not installed properly, dust or water may enter the outdoor unit and fire or electric shock may result.
- **When installing and moving the air conditioner to another site, do not charge the it with a refrigerant different from the refrigerant specified on the unit.**
 - If a different refrigerant or air is mixed with the original refrigerant, the refrigerant cycle may malfunction and the unit may be damaged.
- **If the air conditioner is installed in a small room, measures must be taken to prevent the refrigerant concentration from exceeding the safety limit even if the refrigerant should leak.**
 - Consult the dealer regarding the appropriate measures to prevent the safety limit from being exceeded. Should the refrigerant leak and cause the safety limit to be exceeded, hazards due to lack of oxygen in the room could result.
- **When moving and reinstalling the air conditioner, consult the dealer or an authorized technician.**
 - If the air conditioner is installed improperly, water leakage, electric shock, or fire may result.
- **After completing installation work, make sure that refrigerant gas is not leaking.**
 - If the refrigerant gas leaks and is exposed to a fan heater, stove, oven, or other heat source, it may generate noxious gases.
- **Do not reconstruct or change the settings of the protection devices.**
 - If the pressure switch, thermal switch, or other protection device is shorted and operated forcibly, or parts other than those specified by Mitsubishi Electric are used, fire or explosion may result.
- **To dispose of this product, consult your dealer.**
- **Do not use a leak detection additive.**

1.2. Precautions for devices that use R410A or R407C refrigerant

Caution:

- **Do not use the existing refrigerant piping.**
 - The old refrigerant and refrigerator oil in the existing piping contains a large amount of chlorine which may cause the refrigerator oil of the new unit to deteriorate.
- **Use refrigerant piping made of C1220 (Cu-DHP) phosphorus deoxidized copper as specified in the JIS H3300 “Copper and copper alloy seamless pipes and tubes”. In addition, be sure that the inner and outer surfaces of the pipes are clean and free of hazardous sulphur, oxides, dust/dirt, shaving particles, oils, moisture, or any other contaminant.**
 - Contaminants on the inside of the refrigerant piping may cause the refrigerant residual oil to deteriorate.
- **Store the piping to be used during installation indoors and keep both ends of the piping sealed until just before brazing. (Store elbows and other joints in a plastic bag.)**
 - If dust, dirt, or water enters the refrigerant cycle, deterioration of the oil and compressor trouble may result.
- **Use ester oil, ether oil or alkylbenzene (small amount) as the refrigerator oil to coat flares and flange connections.**
 - The refrigerator oil will degrade if it is mixed with a large amount of mineral oil.
- **Use liquid refrigerant to fill the system.**
 - If gas refrigerant is used to seal the system, the composition of the refrigerant in the cylinder will change and performance may drop.

- **Do not use a refrigerant other than R410A or R407C.**
 - If another refrigerant (R22, etc.) is used, the chlorine in the refrigerant may cause the refrigerant oil to deteriorate.
- **Use a vacuum pump with a reverse flow check valve.**
 - The vacuum pump oil may flow back into the refrigerant cycle and cause the refrigerant oil to deteriorate.
- **Do not use the following tools that are used with conventional refrigerants.**
(Gauge manifold, charge hose, gas leak detector, reverse flow check valve, refrigerant charge base, vacuum gauge, refrigerant recovery equipment.)
 - If the conventional refrigerant and refrigerator oil are mixed in the R410A or R407C, the refrigerant may deteriorate.
 - If water is mixed in the R410A or R407C, the refrigerant oil may deteriorate.
 - Since R410A or R407C does not contain any chlorine, gas leak detectors for conventional refrigerants will not react to it.
- **Do not use a charging cylinder.**
 - Using a charging cylinder may cause the refrigerant to deteriorate.
- **Be especially careful when managing the tools.**
 - If dust, dirt, or water gets in the refrigerant cycle, the refrigerant may deteriorate.

1.3. Before getting installed

⚠ Caution:

- **Do not install the unit where combustible gas may leak.**
 - If the gas leaks and accumulates around the unit, an explosion may result.
- **Do not use the air conditioner where food, pets, plants, precision instruments, or artwork are kept.**
 - The quality of the food, etc. may deteriorate.
- **Do not use the air conditioner in special environments.**
 - Oil, steam, sulfuric smoke, etc. can significantly reduce the performance of the air conditioner or damage its parts.
- **When installing the unit in a hospital, communication station, or similar place, provide sufficient protection against noise.**
 - The inverter equipment, private power generator, high-frequency medical equipment, or radio communication equipment may cause the air conditioner to operate erroneously, or fail to operate. On the other hand, the air conditioner may affect such equipment by creating noise that disturbs medical treatment or image broadcasting.
- **Do not install the unit on a structure that may cause leakage.**
 - When the room humidity exceeds 80 % or when the drain pipe is clogged, condensation may drip from the indoor unit. Perform collective drainage work together with the outdoor unit, as required.
- **The indoor models should be installed the ceiling over than 2.5 m from floor.**

1.4. Before getting installed (moved) - electrical work

⚠ Caution:

- **Ground the unit.**
 - Do not connect the ground wire to gas or water pipes, lightning rods, or telephone ground lines. Improper grounding may result in electric shock.

2. Indoor unit accessories

The unit is provided with the following accessories:

Type 40 - 140

No.	Accessories	Quantity
①	Insulation pipe (small)	1
②	Insulation cover	1
③	Tie band (small)	1
④	Tie band (large)	4
⑤	Drain hose	1
⑥	Washer	8
⑦	Hose band	1
⑧	Attachment connector	2

- **Install the power cable so that tension is not applied to the cable.**
 - Tension may cause the cable to break and generate heat and cause a fire.
- **Install an leak circuit breaker, as required.**
 - If an leak circuit breaker is not installed, electric shock may result.
- **Use power line cables of sufficient current carrying capacity and rating.**
 - Cables that are too small may leak, generate heat, and cause a fire.
- **Use only a circuit breaker and fuse of the specified capacity.**
 - A fuse or circuit breaker of a larger capacity or a steel or copper wire may result in a general unit failure or fire.
- **Do not wash the air conditioner units.**
 - Washing them may cause an electric shock.
- **Be careful that the installation base is not damaged by long use.**
 - If the damage is left uncorrected, the unit may fall and cause personal injury or property damage.
- **Install the drain piping according to this Installation Manual to ensure proper drainage. Wrap thermal insulation around the pipes to prevent condensation.**
 - Improper drain piping may cause water leakage and damage to furniture and other possessions.
- **Be very careful about product transportation.**
 - Only one person should not carry the product if it weighs more than 20 kg.
 - Some products use PP bands for packaging. Do not use any PP bands for a means of transportation. It is dangerous.
 - Do not touch the heat exchanger fins. Doing so may cut your fingers.
 - When transporting the outdoor unit, suspend it at the specified positions on the unit base. Also support the outdoor unit at four points so that it cannot slip sideways.
- **Safely dispose of the packing materials.**
 - Packing materials, such as nails and other metal or wooden parts, may cause stabs or other injuries.
 - Tear apart and throw away plastic packaging bags so that children will not play with them. If children play with a plastic bag which was not torn apart, they face the risk of suffocation.

1.5. Before starting the test run

⚠ Caution:

- **Turn on the power at least 12 hours before starting operation.**
 - Starting operation immediately after turning on the main power switch can result in severe damage to internal parts. Keep the power switch turned on during the operational season.
- **Do not touch the switches with wet fingers.**
 - Touching a switch with wet fingers can cause electric shock.
- **Do not touch the refrigerant pipes during and immediately after operation.**
 - During and immediately after operation, the refrigerant pipes are may be hot and may be cold, depending on the condition of the refrigerant flowing through the refrigerant piping, compressor, and other refrigerant cycle parts. Your hands may suffer burns or frostbite if you touch the refrigerant pipes.
- **Do not operate the air conditioner with the panels and guards removed.**
 - Rotating, hot, or high-voltage parts can cause injuries.
- **Do not turn off the power immediately after stopping operation.**
 - Always wait at least five minutes before turning off the power. Otherwise, water leakage and trouble may occur.

Type 200 · 250

No.	Accessories	Quantity
①	Insulation pipe (small)	1
②	Insulation pipe (medium)	1
③	Tie band (small)	1
④	Tie band (large)	4
⑤	Drain hose	1
⑥	Washer	8
⑦	Hose band	1

3. Selecting an installation site

- Select a location so that air can be blown into all corners of the room.
- Avoid locations exposed to outside air.
- Select a location free of obstructions to the airflow in and out of the unit.
- Avoid locations exposed to steam or oil vapour.
- Avoid locations where combustible gas may leak, settle or be generated.
- Avoid installation near machines emitting high-frequency waves (high-frequency welders, etc.)
- Avoid locations where the airflow is directed at a fire alarm sensor. (Hot air could trigger the alarm during the heating operation.)
- Avoid places where acidic solutions are frequently handled.
- Avoid places where sulphur-based or other sprays are frequently used.
- If the unit is run for long hours when the air above the ceiling is at high temperature/high humidity (dew point above 26 °C), due condensation may be produced in the indoor unit. When operating the units in this condition, add insulation material (10-20 mm) to the entire surface of the indoor unit to avoid due condensation.

⚠ Warning:

Install the indoor unit on a ceiling strong enough to sustain its weight. If the ceiling lacks strength, it may cause the unit to fall down, resulting in an injury.

3.1. Installation and servicing space

Refrigerant piping, drain piping, wiring, and other components should be installed outside the  areas, and free of the access doors to ensure that they do not hinder fan maintenance.

[Fig. 3.1.1] (P. 2)

- Type 40 - 140
- Type 200 · 250
- Ⓐ Fan and motor removal door
- Ⓑ Duct dimension

4. Fixing hanging bolts

4.1. Fixing hanging bolts

(Give site of suspension strong structure.)

Hanging structure

- Ceiling: The ceiling structure varies from building to one another. For detailed information, consult your construction company.
 - If necessary, reinforce the hanging bolts with anti-quake supporting members as countermeasures against earthquakes.
* Use M10 for hanging bolts and anti-quake supporting members (field supply).
- ① Reinforcing the ceiling with additional members (edge beam, etc.) must be required to keep the ceiling at level and to prevent the ceiling from vibrations.
 - ② Cut and remove the ceiling members.
 - ③ Reinforce the ceiling members, and add other members for fixing the ceiling boards.

5. Installing the unit

5.1. Hanging the unit body

- ▶ Bring the indoor unit to an installation site as it is packed.
- ▶ To hang the indoor unit, use a lifting machine to lift and pass through the hanging bolts.

[Fig. 5.1.1] (P. 2)

- Ⓐ Unit body
- Ⓑ Lifting machine

[Fig. 5.1.2] (P. 2)

- Ⓒ Nuts (field supply)
- Ⓓ Washers
- Ⓔ M10 Hanging bolt (field supply)

Note:

Always install access doors in the specified positions for service maintenance.

Type	A	B	C	D
PEFY-P40-50-63VMH-E	680	754	550	600
PEFY-P71-80VMH-E	930	1004	800	850
PEFY-P100-125-140VMH-E	1130	1204	1000	1050
PEFY-P200-250VMH-E	1250	1326	1100	1100

⚠ Warning:

Install the unit on a ceiling strong enough to support its weight.

- If the unit is mounted on a structure of insufficient strength it may fall causing injury.

[Fig. 3.1.2] (P. 2)

- Type 40 - 140
- Type 200 · 250
- Ⓑ Duct dimension
- Ⓒ Electrical components case
- Ⓓ Air inlet
- Ⓔ Top of unit
- Ⓕ Access door
- Ⓖ Servicing space
- Ⓗ Air outlet
- Ⓘ Hanging bolt spacing
- Ⓚ Ceiling
- Ⓛ 100 min.
- Ⓜ 20 min.

3.2. Combining indoor units with outdoor units

For combining indoor units with outdoor units, refer to the outdoor unit installation manual.

[Fig. 4.1.1] (P.2)

- Ⓐ Center of gravity

Center of gravity and Product Weight

Model name	W	L	H	X	Y	Z	Product Weight (kg)
PEFY-P40VMH-E	814	754	210	374	440	190	44
PEFY-P50VMH-E	814	754	210	374	440	190	45
PEFY-P63VMH-E	814	754	210	374	440	190	45
PEFY-P71VMH-E	814	1004	210	394	584	190	50
PEFY-P80VMH-E	814	1004	210	394	584	190	50
PEFY-P100VMH-E	814	1204	210	364	649	190	70
PEFY-P125VMH-E	814	1204	210	364	649	190	70
PEFY-P140VMH-E	814	1204	210	364	649	190	70
PEFY-P200VMH-E	1034	1326	255	462	660	235	100
PEFY-P250VMH-E	1034	1326	255	462	660	235	100

5.2. Confirming the unit's position and fixing hanging bolts

- ▶ Use the gage supplied with the panel to confirm that the unit body and hanging bolts are positioned in place. If they are not positioned in place, it may result in dew drops due to wind leak. Be sure to check the positional relationship.
- ▶ Use a level to check that the surface indicated by Ⓐ is at level. Ensure that the hanging bolt nuts are tightened to fix the hanging bolts.
- ▶ To ensure that drain is discharged, be sure to hang the unit at level using a level.

[Fig. 5.2.1] (P. 2)

- Ⓐ Bottom of indoor unit

⚠ Caution:

Be sure to install the unit body at level.

6. Refrigerant pipe and drain pipe specifications

To avoid dew drops, provide sufficient antisweating and insulating work to the refrigerant and drain pipes.

When using commercially available refrigerant pipes, be sure to wind commercially available insulating material (with a heat-resisting temperature of more than 100 °C and thickness given below) onto both liquid and gas pipes.

Be also sure to wind commercially available insulating material (with a form polyethylene's specific gravity of 0.03 and thickness given below) onto all pipes which pass through rooms.

- ① Select the thickness of insulating material by pipe size.

Pipe size	Insulating material's thickness
6.4 mm to 25.4 mm	More than 10 mm
28.6 mm to 38.1 mm	More than 15 mm

- ② If the unit is used on the highest story of a building and under conditions of high temperature and humidity, it is necessary to use pipe size and insulating material's thickness more than those given in the table above.
- ③ If there are customer's specifications, simply follow them.

6.1. Refrigerant pipe and drain pipe specifications

[Fig. 6.1.1] (P. 2)

- Ⓐ Flare cutting dimensions Ⓑ Refrigerant pipe sizes & Flare nut tightening torque
 Ⓒ Apply refrigerating machine oil over the entire flare seat surface

Ⓐ Flare cutting dimensions

Copper pipe O.D. (mm)	Flare dimensions ϕA dimensions (mm)
$\phi 6.35$	8.7 – 9.1
$\phi 9.52$	12.8 – 13.2
$\phi 12.7$	16.2 – 16.6
$\phi 15.88$	19.3 – 19.7
$\phi 19.05$	22.9 – 23.3

Ⓑ Refrigerant pipe sizes & Flare nut tightening torque

	R410A				R407C or R22				Flare nut O.D.	
	Liquid pipe		Gas pipe		Liquid pipe		Gas pipe		Liquid pipe (mm)	Gas pipe (mm)
	Pipe size	Tightening torque (N·m)	Pipe size	Tightening torque (N·m)	Pipe size	Tightening torque (N·m)	Pipe size	Tightening torque (N·m)		
P40	O.D. $\phi 6.35$ (1/4")	14 – 18	O.D. $\phi 12.7$ (1/2")	49 – 61	O.D. $\phi 6.35$ (1/4")	14 – 18	O.D. $\phi 12.7$ (1/2")	49 – 61	17	27
P50	O.D. $\phi 6.35$ (1/4")	34 – 42	O.D. $\phi 12.7$ (1/2")	68 – 82	O.D. $\phi 9.52$ (3/8")	34 – 42*	O.D. $\phi 15.88$ (5/8")	68 – 82*	22	29
P63/71/80	O.D. $\phi 9.52$ (3/8")	34 – 42	O.D. $\phi 15.88$ (5/8")	68 – 82	O.D. $\phi 9.52$ (3/8")	34 – 42	O.D. $\phi 15.88$ (5/8")	68 – 82	22	29
P100/125/140	O.D. $\phi 9.52$ (3/8")	34 – 42	O.D. $\phi 15.88$ (5/8")	100 – 120	O.D. $\phi 9.52$ (3/8")	34 – 42	O.D. $\phi 19.05$ (3/4")	100 – 120*	22	36

* Use the provided flare nut for the following pipes: Liquid pipe of P50, P100, P125, P140, and gas pipe of P50.

	R410A		R407C or R22	
	Liquid pipe	Gas pipe	Liquid pipe	Gas pipe
P200	O.D. $\phi 9.52$ (3/8")	O.D. $\phi 19.05$ (3/4")	O.D. $\phi 12.7$ (1/2")	O.D. $\phi 25.4$ (1")
P250	O.D. $\phi 9.52$ (3/8")	O.D. $\phi 22.2$ (7/8")	O.D. $\phi 12.7$ (1/2")	O.D. $\phi 28.58$ (1-1/8")

6.2. Refrigerant pipe, drain pipe and filling port

[Fig. 6.2.1] (P. 3)

Type 40 - 140
 Type 200 - 250

- Ⓐ Air inlet Ⓑ Refrigerant piping (liquid)
 Ⓒ Refrigerant piping (gas) Ⓓ Control box
 Ⓔ Drain outlet Ⓕ Air outlet

6.3. Request for refrigerant piping connection

Connecting refrigerant piping

- After connecting refrigerant piping, insulate the joints (flared joints) with thermal insulation tubing as shown below.

[Fig. 6.3.1] (P. 3)

Type 40 - 140

- Ⓐ Thermal insulation tubing ①

Ⓑ Caution:

Pull out the thermal insulation on the refrigerant piping at the site, insert the flare nut to flare the end, and replace the insulation in its original position.

Take care to ensure that condensation does not form on exposed copper piping.

- Ⓒ Liquid end of refrigerant piping Ⓓ Gas end of refrigerant piping
 Ⓔ Site refrigerant piping Ⓕ Main body
 Ⓖ Marked "GAS" Ⓗ Marked "OUTSIDE"
 Ⓙ Flared insulation (supplied) ② Ⓙ Marked "INSIDE"
 Ⓚ Thermal insulation Ⓛ Pull
 Ⓜ Flare nut Ⓝ Return to original position
 Ⓞ Ensure that there is no gap here Ⓟ Plate on main body
 Ⓠ Outside Ⓡ Inside
 Ⓢ Remove tape
 Ⓣ Thermal insulation tubing (small) (supplied) ①
 Ⓤ Tie (large) (supplied) ④
 Ⓡ Ensure that there is no gap here. Place join upwards.

[Fig. 6.3.2] (P. 3)

Type 200 - 250

- Ⓐ Thermal insulation tubing ①

Ⓑ Caution:

Pull out the thermal insulation on the refrigerant piping at the site, braze the piping, and replace the insulation in its original position.

Take care to ensure that condensation does not form on exposed copper piping.

- Ⓒ Refrigerant piping (liquid) Ⓓ Refrigerant piping (gas)
 Ⓔ Main body Ⓕ Thermal insulation tubing ②
 Ⓖ Site refrigerant piping
 Ⓗ Ensure that there are no gaps between the insulation and the main body.
 Ⓙ Thermal insulation tubing (small) (supplied) ①
 Ⓤ Ties (large) (supplied) ④
 Ⓚ Ensure that there is no gap here. Place join upwards.
 Ⓛ Thermal insulation tubing (medium) (supplied) ②
 Ⓜ Cut
 Ⓝ Release gas before removing the brazing.
 Ⓞ Thermal insulation Ⓟ Pull
 Ⓠ Flared pipe end Ⓡ Wrap with damp cloth
 Ⓢ Return to original position Ⓣ Ensure that there is no gap here.

⚠ Caution:

Before removing the brazing, cut off the end of the pipe to release any gas. If the gas is not released, the pipe may fly off.

- Remove and discard the rubber bung which is inserted in the end of the unit piping.
- Flare the end of the site refrigerant piping.
- Pull out the thermal insulation on the site refrigerant piping, braze the unit piping, and replace the insulation in its original position.

* Before brazing the refrigerant piping, **always wrap the piping on the main body, and the thermal insulation piping, with damp cloths to prevent heat shrinkage and burning the thermal insulation tubing.** Take care to ensure that the flame does not come into contact with the main body itself.

Refrigerant amount adjustment

Refer to the installation manual for the outdoor unit for details on adjusting the amount of refrigerant.

7. Connecting refrigerant pipes and drain pipes

7.1. Refrigerant piping work

This piping work must be done in accordance with the installation manuals for both outdoor unit and BC controller (simultaneous cooling and heating series R2).

- Series R2 is designed to operate in a system that the refrigerant pipe from an outdoor unit is received by BC controller and branches at the BC controller to connect between indoor units.
- For constraints on pipe length and allowable difference of elevation, refer to the outdoor unit manual.
- The method of pipe connection is flare connection (only 40~140).
- The method of pipe connection is brazing connection (only 200 · 250).

Cautions On Refrigerant Piping

- ▶ **Be sure to use non-oxidative brazing for brazing to ensure that no foreign matter or moisture enter into the pipe.**
- ▶ **Be sure to apply refrigerating machine oil over the flare connection seating surface and tighten the connection using a double spanner.**
- ▶ **Provide a metal brace to support the refrigerant pipe so that no load is imparted to the indoor unit end pipe. This metal brace should be provided 50 cm away from the indoor unit's flare connection.**

⚠ Warning:

When installing and moving the unit, do not charge it with refrigerant other than the refrigerant specified on the unit.

- Mixing of a different refrigerant, air, etc. may cause the refrigerant cycle to malfunction and result in severe damage.

⚠ Caution:

- **Use refrigerant piping made of C1220 (Cu-DHP) phosphorus deoxidized copper as specified in the JIS H3300 "Copper and copper alloy seamless pipes and tubes". In addition, be sure that the inner and outer surfaces of the pipes are clean and free of hazardous sulphur, oxides, dust/dirt, shaving particles, oils, moisture, or any other contaminant.**
- **Never use existing refrigerant piping.**
 - The large amount of chlorine in conventional refrigerant and refrigerant oil in the existing piping will cause the new refrigerant to deteriorate.

- **Store the piping to be used during installation indoors and keep both ends of the piping sealed until just before brazing.**
 - If dust, dirt, or water gets into the refrigerant cycle, the oil will deteriorate and the compressor may fail.
- **Use Suniso 4GS or 3GS (small amount) refrigerator oil to coat the flare and flange connection part. (For models using R22)**
- **Use ester oil, ether oil or alkylbenzene (small amount) as the refrigerant oil to coat flares and flange connections. (For models using R410A or R407C)**
 - The refrigerant used in the unit is highly hygroscopic and mixes with water and will degrade the refrigerant oil.

7.2. Drain piping work

1. Ensure that the drain piping is downward (pitch of more than 1/100) to the outdoor (discharge) side. Do not provide any trap or irregularity on the way. (Ⓐ)
2. Ensure that any cross-wise drain piping is less than 20 m (excluding the difference of elevation). If the drain piping is long, provide metal braces to prevent it from waving. Never provide any air vent pipe. Otherwise drain may be ejected.
3. Use a hard vinyl chloride pipe VP-25 (with an external diameter of 32 mm) for drain piping.
4. Ensure that collected pipes are 10 cm lower than the unit body's drain port as shown in (Ⓑ).
5. Do not provide any odor trap at the drain discharge port.
6. Put the end of the drain piping in a position where no odor is generated.
7. Do not put the end of the drain piping in any drain where ionic gases are generated.

[Fig. 7.2.1] (P. 4)

- (A) Downward slope 1/100 or more
- (B) Drain hose (Accessory)
- (C) Indoor unit
- (D) Collective piping
- (E) Maximize this length to approx. 10 cm

8. Duct work

- When connecting ducts, insert a canvas duct between the main body and the duct.
- Use non-combustible duct components.
- Install sufficient thermal insulation to prevent condensation forming on air inlet and air outlet duct flanges, and air outlet ducts.

[Fig. 8.0.1] (P. 4)

- (A) Air inlet
- (B) Air filter (supplied at site)
- (C) Duct
- (D) Canvas duct

- (E) Access door
- (F) Ceiling
- (G) Ensure sufficient length to prevent short cycling
- (H) Air outlet
- (I) Keep duct-work length 850 mm or more

⚠ Caution:

Inlet duct is 850 mm or more necessary to construct. Always install horizontal.

9. Electrical wiring

Precautions on electrical wiring

⚠ Warning:

Electrical work should be done by qualified electrical engineers in accordance with "Engineering Standards For Electrical Installation" and supplied installation manuals. Special circuits should also be used. If the power circuit lacks capacity or has an installation failure, it may cause a risk of electric shock or fire.

1. Be sure to take power from the special branch circuit.
2. Be sure to install an earth leakage breaker to the power.
3. Install the unit to prevent that any of the control circuit cables (remote controller, transmission cables) is brought in direct contact with the power cable outside the unit.
4. Ensure that there is no slack on all wire connections.
5. Some cables (power, remote controller, transmission cables) above the ceiling may be bitten by mice. Use as many metal pipes as possible to insert the cables into them for protection.

6. Never connect the power cable to leads for the transmission cables. Otherwise the cables would be broken.
7. Be sure to connect control cables to the indoor unit, remote controller, and the outdoor unit.
8. Put the unit to the ground on the outdoor unit side.
9. Select control cables from the conditions given in page 10.

⚠ Caution:

Be sure to put the unit to the ground on the outdoor unit side. Do not connect the earth cable to any gas pipe, water pipe, lightning rod, or telephone earth cable. Incomplete grounding may cause a risk of electric shock.

Types of control cables

1. Wiring transmission cables

- Types of transmission cables
Design wiring in accordance with the following table <Table 1>.
- Cable diameter
More than 1.25 mm²

<Table 1>

System configuration	For a single-refrigerant system		For a multi-refrigerant system
Transmission cable length	Less than 120 m		Regardless of length
Facility example (for noise judgment)	Residence or independent store without noise	Building, clinic, hospital or communications station without noise supposedly generated from inverter equipment, private power generator, high-frequency medical equipment, radio-used communications equipment and so on	All facilities
Types of transmission cables	VCTF, VCTFK, CVV, CVS, VVR, VVF, VCT or shielding wire CVVS or CPEVS		Shielding wire CVVS or CPEVS
Length	Less than 120 m		Less than 200 m

2. Remote controller cables

	MA remote controller	M-NET remote controller
Types of cables	2-core cable (unshielded)	Non-shielding wire for up to 10 m; the same specifications as "1." Wiring transmission cables for more than 10 m
Cable diameter	0.3 to 1.25 mm ²	0.3 to 1.25 mm ²
Length	Less than 200 m	Add any portion in excess of 10 m to within the longest allowable transmission cable length 200 m (Shielding portion is more than 1.25 mm ²)

9.1. Power supply wiring

- Power supply cords of appliances shall not be lighter than design 245 IEC 57 or 227 IEC 57.
- A switch with at least 3 mm contact separation in each pole shall be provided by the Air conditioner installation.

Power cable size: more than 1.5 mm²

[Fig. 9.1.1] (P. 4)

- Ⓐ Switch 16 A
- Ⓑ Overcurrent protection 16 A
- Ⓒ Indoor unit
- Ⓓ Total operating current be less than 16 A
- Ⓔ Pull box

[Selecting non-fuse breaker (NF) or earth leakage breaker (NV)]

To select NF or NV instead of a combination of Class B fuse with switch, use the following:

- In the case of Class B fuse rated 15 A or 20 A,
NF model name (MITSUBISHI): NF30-CS (15 A) (20 A)
NV model name (MITSUBISHI): NV30-CA (15 A) (20 A)

Use an earth leakage breaker with a sensitivity of less than 30 mA 0.1 s.

⚠ Caution:

Do not use anything other than the correct capacity breaker and fuse. Using fuse, wire or copper wire with too large capacity may cause a risk of malfunction or fire.

9.2. Connecting remote controller, indoor and outdoor transmission cables

(Remote controller is optionally available.)

- Connect indoor unit TB5 and outdoor unit TB3. (Non-polarized 2-wire)
 The "S" on indoor unit TB5 is a shielding wire connection. For specifications about the connecting cables, refer to the outdoor unit installation manual.
- Install a remote controller following the manual supplied with the remote controller.
- Connect the "1" and "2" on indoor unit TB15 to a MA remote controller. (Non-polarized 2-wire)
- Connect the "M1" and "M2" on indoor unit TB5 to a M-NET remote controller. (Non-polarized 2-wire)
- Connect the remote controller's transmission cable within 10 m using a 0.75 mm² core cable. If the distance is more than 10 m, use a 1.25 mm² junction cable.

[Fig. 9.2.1] (P.4) MA Remote controller

[Fig. 9.2.2] (P.4) M-NET Remote controller

- Ⓐ Terminal block for indoor transmission cable
- Ⓑ Terminal block for outdoor transmission cable
- Ⓒ Remote controller

- DC 9 to 13 V between 1 and 2 (MA remote controller)
- DC 24 to 30 V between M1 and M2 (M-NET remote controller)

[Fig. 9.2.3] (P.4) MA Remote controller

[Fig. 9.2.4] (P.4) M-NET Remote controller

- Ⓐ Non-polarized
- Ⓑ Upper level (TB15)
- Ⓒ Remote Controller
- Ⓓ Lower level (TB5)

- The MA remote controller and the M-NET remote controller cannot be used at the same time or interchangeably.

Note:

Ensure that the wiring is not pinched when fitting the terminal box cover. Pinching the wiring may cut it.

⚠ Caution:

Install wiring so that it is not tight and under tension. Wiring under tension may break, or overheat and burn.

- Fix power source wiring to control box by using buffer bushing for tensile force. (PG connection or the like.) Connect transmission wiring to transmission terminal block through the knockout hole of control box using ordinary bushing.
- After wiring is complete, make sure again that there is no slack on the connections, and attach the cover onto the control box in the reverse order removal.

⚠ Caution:

Wire the power supply so that no tension is imparted. Otherwise disconnection, heating or fire result.

9.3. Connecting electrical connections

Verify that the model name on the operating instructions on the cover of the control box is the same as the model name on the nameplate.

Step 1

Remove the screws holding the terminal box cover in place.

- Type 40 - 140 (2 screws) Fig.1
- Type 200 · 250 (4 screws) Fig.2

[Fig. 9.3.1] (P. 4)

- Fig.1
- Fig.2
- Ⓐ Screws
- Ⓑ Terminal box cover
- Ⓒ Control box cover
- Ⓓ Control box

Note:

Ensure that the wiring is not pinched when fitting the terminal box cover. Pinching the wiring may cut it.

⚠ Caution:

Install wiring so that it is not tight and under tension. Wiring under tension may break, or overheat and burn.

- Fix power source wiring to control box by using buffer bushing for tensile force. (PG connection or the like.) Connect transmission wiring to transmission terminal block through the knockout hole of control box using ordinary bushing.
- After wiring is complete, make sure again that there is no slack on the connections, and attach the cover onto the control box in the reverse order removal.

[Fig. 9.3.2] (P. 4)

- Ⓐ To prevent external tensile force from applying to the wiring connection section of power source terminal block use buffer bushing like PG connection or the like.
- Ⓑ Power source wiring
- Ⓒ Tensile force
- Ⓓ Use ordinary bushing
- Ⓔ Transmission wiring

⚠ Caution:

Wire the power supply so that no tension is imparted. Otherwise disconnection, heating or fire result.

9.4. Selecting the static pressure

Type 40 - 140

The external static pressure can be changed over as required. For the selection of the static pressure, insert an attachment between the connector of the motor lead wire and the control box.

The relationship between the attachment and the external static pressure is shown below.

Attachment (Red) External static pressure 200 Pa

Attachment (Blue) External static pressure 50 Pa

Type 200 · 250

The external static pressure can be changed over as required.

For the selection of static pressure, replace the connector of the motor lead wire by the connector (blue) inside the control box for insertion.

9.5. Setting addresses

(Be sure to operate with the main power turned OFF.)

[Fig. 9.5.1] (P. 4)

<Address board>

- There are two types of rotary switch setting available: setting addresses 1 to 9 and over 10, and setting branch numbers.
 - ① How to set addresses
Example: If Address is "3", remain SW12 (for over 10) at "0", and match SW11 (for 1 to 9) with "3".
 - ② How to set branch numbers SW14 (Series R2 only)
Match the indoor unit's refrigerant pipe with the BC controller's end connection number. Remain other than R2 at "0".
- The rotary switches are all set to "0" when shipped from the factory. These switches can be used to set unit addresses and branch numbers at will.
- The determination of indoor unit addresses varies with the system at site. Set them referring to technical data.

Notes:

Please set the switch SW5 according to the power supply voltage.

- Set SW5 to 240 V side when the power supply is 230 and 240 volts.
- When the power supply is 220 volts, set SW5 to 220 V side.

9.6. Sensing room temperature with the built-in sensor in a remote controller

If you want to sense room temperature with the built-in sensor in a remote controller, set SW1-1 on the control board to "ON".

This product is designed and intended for use in the residential, commercial and light-industrial environment.

The product at hand is based on the following EU regulations:

- Low Voltage Directive 73/23/EEC
- Electromagnetic Compatibility Directive 89/336/EEC

Please be sure to put the contact address/telephone number on this manual before handing it to the customer.